

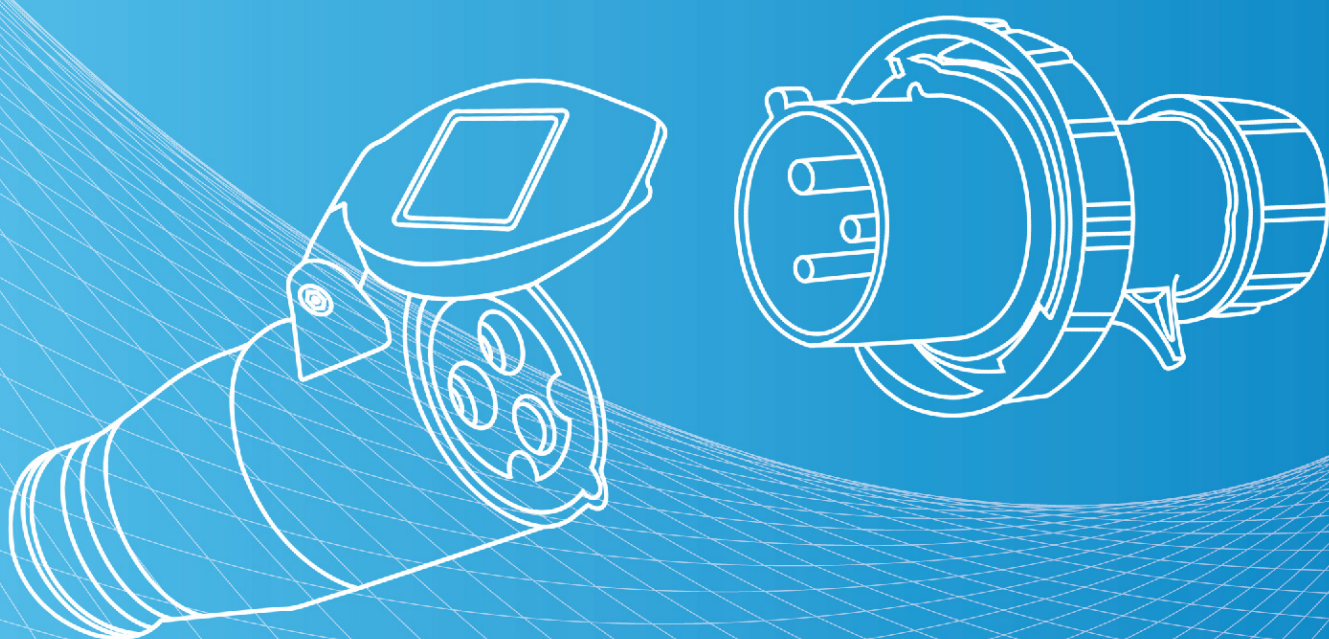

อุปกรณ์เชื่อมต่อ  
ในงานอุตสาหกรรมทั่วโลก

Industrial interconnecting devices suitable

For the **WORLD**



บริษัท สยาม โกลบอล กรุ๊ป จำกัด  
SIAM GLOBAL GROUP CO.,LTD.

website : [www.sgb.co.th](http://www.sgb.co.th)

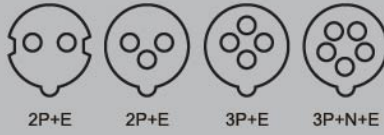

# Power Plug

## พาวเวอร์ปลั๊ก

### ข้อมูลทางเทคนิค Technical Data

แรงดันไฟฟ้า  
(Rated voltage)

AC : 24, 42, 110, 127, 220, 240, 380, 415, 660V  
DC : 24, 110, 220, 440

กระแสไฟ  
(Rated current)

: 16, 32, 63, 125A

ความถี่  
(Rated frequency)

: 50~60Hz

จำนวน  
(Plaguy)

: 1P+N+  (2 ขา / two Poles)

: 2P+  (3 ขา / three Poles)



: 3P+  (4 ขา / Four Poles)



: 3P+N+  (5 ขา / Five Poles)

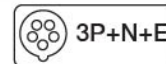

ตำแหน่งของสายดิน  
(Earth contact place)

: กำหนดตามเข็มนาฬิกา 1-12 / Time as clock set 1-12

ระดับความปลอดภัย  
(Safety grade)

: IP44, ,IP54, IP55, IP67





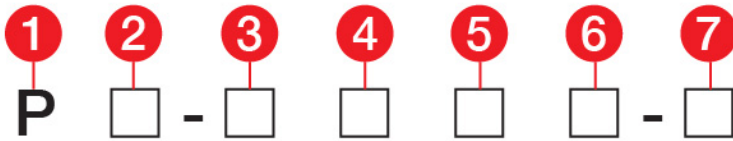
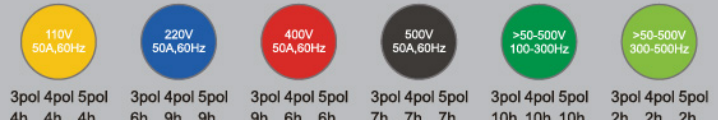
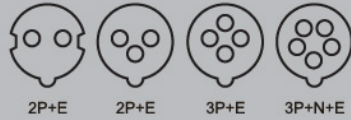



# POWER PLUG พาวเวอร์ปลั๊ก



## ลักษณะของปลั๊ก Model Signification





**1** มาตรฐานสำหรับการเชื่อมต่อ สวิตช์วงจรหรืออุปกรณ์ป้องกัน Stands for circuit switch connector or protection device

**2** รูปแบบ(Generation) : "1, 2, ..."

รหัส (Mode code)	คำอธิบาย (Description)
0 	ปลั๊ก Pulg
1 	เต้ารับ Socket
2 	เต้ารับตัวเมียต่อกกลาง Coupler (connector)
3 	เต้ารับตัวเมียติดตั้งตรง Panel mounting straight socket
4 	เต้ารับตัวเมียติดตั้งเฉียง Panel mounting angled socket
5 	ปลั๊กตัวผู้ติดตั้ง Panel mounting utensil plug
6 	ปลั๊กตัวผู้ Panel mounting utensil plug

**4** กระแสไฟ(Rated current) : "1" = 16A  
: "2" = 32A  
: "3" = 63A  
: "4" = 125A  
: "5" = 16A x 3 socket / 32A x 1 Plug

**5** จำนวนขา(Pole) : 2, 3, 4, 5

ประเภท(Type)	ตัวอย่าง
: "0" Economy type	
: "1" Screwing type IP55	
: "2" Screwing type IP67	
: "3" Europe type	
: "U" Universal	

**7** สัญลักษณ์ตำแหน่งสายดิน (รูปแบบทั่วไป "6h")  / Earth contact place symbol (Regular model "6h") 



# POWER PLUG พาวเวอร์ปลั๊ก

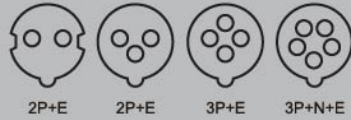

## ตำแหน่งของสายดินตามมาตรฐาน IEC 60309-2

Position of the earthing contact acc. To IEC 60309-3

แรงดันไฟฟ้า (V) Spanung	ความถี่ (Hz) Frequency	2P+E		3P+E		3P+N+E	
		16+32A	63+125A	16+32A	63+125A	16+32A	63+125A
63,5-110 bis 75/130	50+60					4	4
110 bis 130	50+60	4	4	4	4		
120-208 bis 144/130	50+60					9	9
220 bis 250	50+60	6	6	9	9		
220-380 bis 240/130	50+60					6	6
220-380 bis 250/440	50+60					3	3*
250-400 bis 265/460	60					11	11
277	60	5	5				
227-480 bis 280/130	50+60					7	7
347-600 bis 400/690	50+60					5	5
380 bis 415	50+60	9	9	6	6		
380 ; 440	50+60			3	3		
440 bis 460	60			11	11		
480 bis 500	50+60	7	7	7	7		
600 bis 690	50+60			5	5		
uber 50	100 bis 300	10*	10*	10*	10*	10*	10*
uber 50	>300 bis 500	2	2*	2	2*	2	2
ber 50 bis 250	Gleichstrom	3	3				
uber 250	Gleichstrom	8	8				
Versorgung nach Trenntransformator	50+60	12	12	12	12		

\*Nicht standard

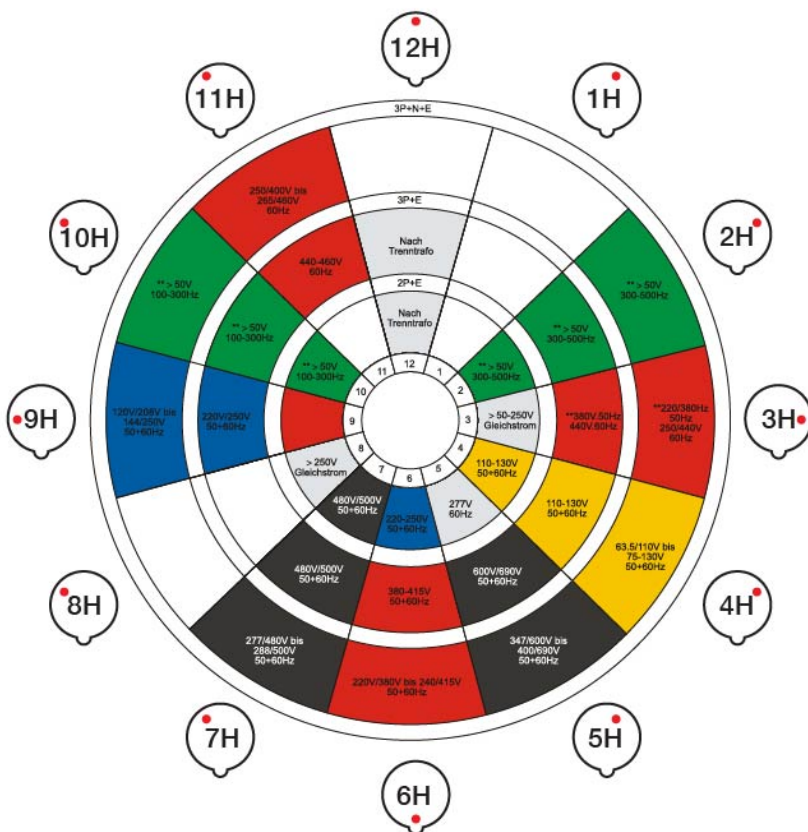

ช่วงแรงดันไฟฟ้า Voltage range (V)	รหัสสี (Color code)
20-25V	Violet
40-50V	white
100-130V	yellow
200-250V	blue
380-480V	red
500-690V	black
>60-500Hz	green
ohne kennfarbe	gray



# POWER PLUG พาวเวอร์ปลั๊ก

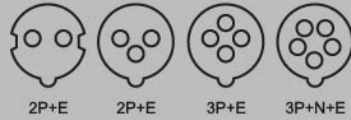

Item one	Protection of the solid	Item two	Protection of the liquid	New	Protection of mechanical impact
IP C	Test without protection	IP 0	Test without protection	IK 00	Test without protection
1	Can prevent damage to solid of 50mm or above (such as: occasional hand contact)	1	Prevention of vertical dripping hazards	05	Impact 0.7 joule
2	Can prevent damage to solid of 12mm or above (such as: size of a finger)	2	Can prevent harm of water spray directly below 15 degrees with the vertical direction	06	Impact 1 joule
3	Can prevent damage to solid of 2.5mm or above (such as: thin tools and thin cables)	3	Can prevent harm of water spray directly below 60 degrees with the vertical direction	07	Impact 2 joule
4	Can prevent damage to solid of 1mm or above (such as: thin tools and thin cables)	4	Can prevent water spraying hazard from all directions up	08	Impact 5 joule
5	Can prevent the harm of dust	5	Can prevent low pressure water spraying hazard from all directions up	09	Impact 10 joule
6	Can completely prevent the harm of dust	6	Can prevent high pressure water spraying hazard from all directions	10	Impact 20 joule
		7	Can prevent 15cm below immers on deleterious effects		According to the VDE0470, section 100 of the external operation of electrical equipment external mechanical injury protection level (IK code), Protection degree of the mechanical impact prevention supplied by the shell is expressed by IK code.  IK code Impact energy/joules
		8	Can prevent the harm of long-term immersion under pressure		



โครงสร้างทั้งหมดผลิตจากเอ็นจิเนียริ่งพลาสติกที่ไม่ลามไฟ  
**FLAME RESISTANT ENGINEERING PLASTIC**

Model:

- P1-013-6h
- P1-023-6h



220/250V  
 2 สาย 3 ขา

IP44



2P+E

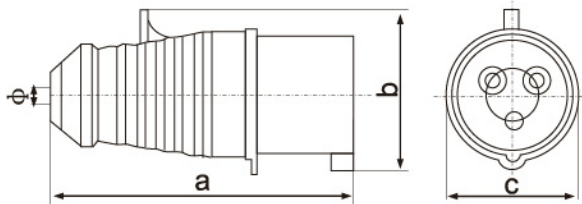

ปลั๊กตัวพู้

		P1-013-6h	P1-023-6h
Earth contact position		6h	
Rated current(A)		16	32
Pole		3	
Dimension(mm)	a	122	141
	b	57	77
	c	50	64
	ø	6	8
Cable nominal cross-section area(mm <sup>2</sup> )		1-2.5	2.5-6
Net Weight(PC)		108 g	171 g
Packing		1/แพ็ค, 10/กล่อง 100/ลัง	10/กล่อง 60/ลัง
Price		<b>60.-</b>	<b>105.-</b>



P1-014-6h



P1-024-6h

380/415V  
 3 สาย 4 ขา

IP44



3P+E

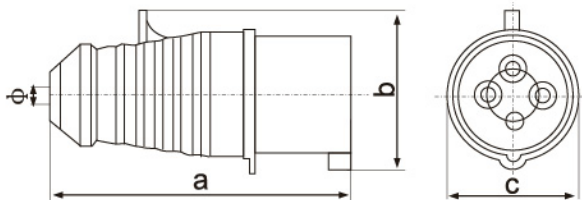

ปลั๊กตัวพู้

		P1-014-6h	P1-024-6h
Earth contact position		6h	
Rated current(A)		16	32
Pole		4	
Dimension(mm)	a	122	141
	b	57	77
	c	50	64
	ø	6	8
Cable nominal cross-section area(mm <sup>2</sup> )		1-2.5	2.5-6
Net Weight(PC)		121 g	190 g
Packing		10/กล่อง 100/ลัง	10/กล่อง 60/ลัง
Price		<b>80.-</b>	<b>135.-</b>



P1-015-6h



P1-025-6h

380/415V  
 3 สาย 5 ขา

IP44



3P+N+E

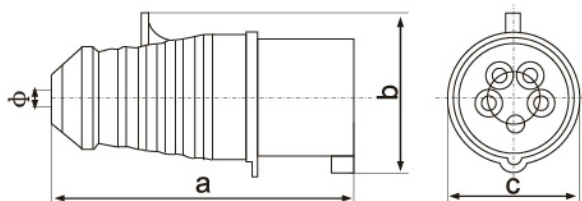

ปลั๊กตัวพู้

		P1-015-6h	P1-025-6h
Earth contact position		6h	
Rated current(A)		16	32
Pole		5	
Dimension(mm)	a	130	144
	b	75	87
	c	64	70
	ø	8	8
Cable nominal cross-section area(mm <sup>2</sup> )		1-2.5	2.5-6
Net Weight(PC)		155 g	227 g
Packing		10/กล่อง 60/ลัง	1/แพ็ค, 10/กล่อง 60/ลัง
Price		<b>95.-</b>	<b>156.-</b>



โครงสร้างทั้งหมดผลิตจากเอ็นอีเอวีเรซิงพลาสติกที่ไม่ลามไฟ  
**FLAME RESISTANT ENGINEERING PLASTIC**

Model:

- P2-0131-6h
- P2-0231-6h



220/250V  
2 สาย 3 ขา

IP55



2P+E

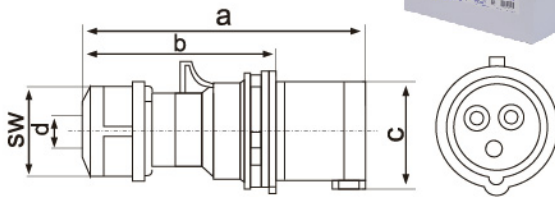

ปลั๊กตัวพู้

		P2-0131-6h	P2-0231-6h
Earth contact position		6h	
Rated current(A)		16	32
	Pole	3	
Dimension(mm)	a	118	146
	b	82	100
	c	47	63
	d	6-15	10-20
	sw	38	50
Cable nominal cross-section area(mm <sup>2</sup> )		1-2.5	2.5-6
Net Weight(PC)		115 g	
Packing		1/แพ็ค. 10/กล่อง 60/ลัง	60/ลัง
Price		<b>100.-</b>	<b>160.-</b>



P2-0141-6h



P2-0241-6h

380/415V  
3 สาย 4 ขา

IP55



3P+E

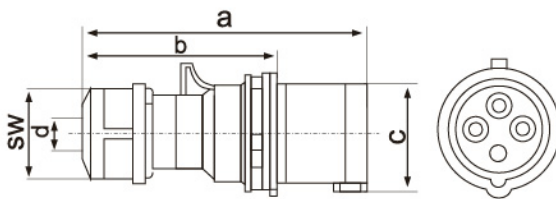

ปลั๊กตัวพู้

		P2-0141-6h	P2-0241-6h
Earth contact position		6h	
Rated current(A)		16	32
	Pole	4	
Dimension(mm)	a	124	146
	b	88	100
	c	53	63
	d	6-15	10-20
	sw	38	50
Cable nominal cross-section area(mm <sup>2</sup> )		1-2.5	2.5-6
Net Weight(PC)			
Packing		10/กล่อง 100/ลัง	10/กล่อง 60/ลัง
Price		<b>130.-</b>	<b>175.-</b>

Model:

P2-0251-6h



380/415V  
3 สาย 5 ขา

IP55



3P+N+E

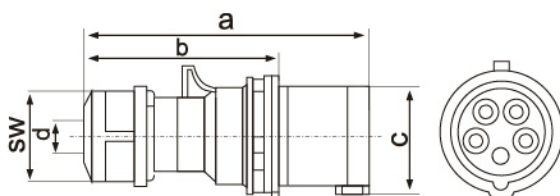

ปลั๊กตัวพู้

		P2-0251-6h
Earth contact position		6h
Rated current(A)		32
	Pole	5
Dimension(mm)	a	152
	b	106
	c	70
	d	10-20
	sw	50
Cable nominal cross-section area(mm <sup>2</sup> )		2.5-6
Net Weight(PC)		
Packing		10/กล่อง 60/ลัง
Price		<b>200.-</b>



### โครงสร้างทั้งหมดผลิตจากเอ็นอีเอวีพีพลาสติกที่ไม่ลามไฟ

### FLAME RESISTANT ENGINEERING PLASTIC



**P2-0132-6h**



**P2-0232-6h**

220/250V  
2 สาย 3 ขา  
IP67



2P+E

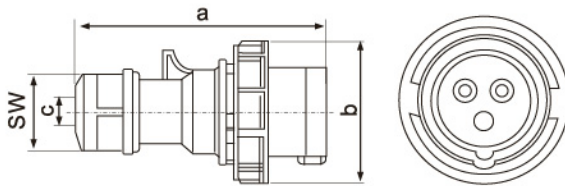

### ปลั๊กตัวพู้

		P2-0132-6h	P2-0232-6h
Earth contact position		6h	
Rated current(A)		16	32
	Pole	3	
Dimension(mm)	a	118	146
	b	80	93
	c	6-15	10-20
	sw	38	50
Cable nominal cross-section area(mm <sup>2</sup> )		1-2.5	2.5-6
Net Weight(PC)			183 g
Packing		10/กล่อง 60/ลัง	10/กล่อง 60/ลัง
Price		<b>130.-</b>	<b>180.-</b>

Model:

- P2-0142-6h
- P2-0242-6h



380/415V  
3 สาย 4 ขา  
IP67



3P+E

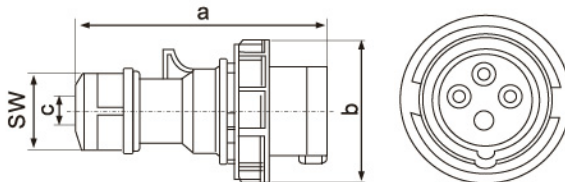

### ปลั๊กตัวพู้

		P2-0142-6h	P2-0242-6h
Earth contact position		6h	
Rated current(A)		16	32
	Pole	4	
Dimension(mm)	a	124	146
	b	79	93
	c	6-15	10-20
	sw	38	50
Cable nominal cross-section area(mm <sup>2</sup> )		1-2.5	2.5-6
Net Weight(PC)		225 g	232 g
Packing		10/กล่อง 60/ลัง	1/แพ็คเกจ, 10/กล่อง 60/ลัง
Price		<b>145.-</b>	<b>200.-</b>

Model:

- P2-0152-6h
- P2-0252-6h



380/415V  
3 สาย 5 ขา  
IP67



3P+N+E

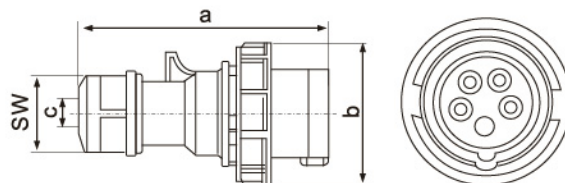

### ปลั๊กตัวพู้

		P2-0152-6h	P2-0252-6h
Earth contact position		6h	
Rated current(A)		16	32
	Pole	5	
Dimension(mm)	a	133	155
	b	87	99
	c	8-16	10-20
	sw	42	50
Cable nominal cross-section area(mm <sup>2</sup> )		1-2.5	2.5-6
Net Weight(PC)			
Packing		10/กล่อง 60/ลัง	10/กล่อง 60/ลัง
Price		<b>160.-</b>	<b>220.-</b>



▶ =สินค้าพร้อมออเดอร์



โครงสร้างทั้งหมดผลิตจากเอ็นวีเนียร์พลาสติกที่ไม่ลามไฟ  
**FLAME RESISTANT ENGINEERING PLASTIC**

Model:

■ P1-0332-6h

▶ P1-0432-6h



220/250V  
2 สาย 3 ขา  
IP67



2P+E

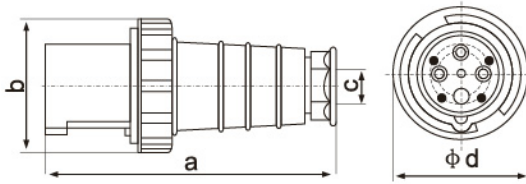

ปลั๊กตัวพู้

		P1-0332-6h	P1-0432-6h
Earth contact position		6h	
Rated current(A)		63	125
Pole		3	
Dimension(mm)	a	231.5	295
	b	110	123
	c	16-38	30-64
	ø	110	123
Cable nominal cross-section area(mm <sup>2</sup> )		6-16	16-50
Net Weight(PC)			
Packing		2/กล่อง 10/ลิ้น	1/กล่อง 10/ลิ้น
Price		<b>600.-</b>	<b>2,200.-</b>

Model:

■ P1-0342-6h

▶ P1-0442-6h



380/415V  
3 สาย 4 ขา  
IP67



3P+E

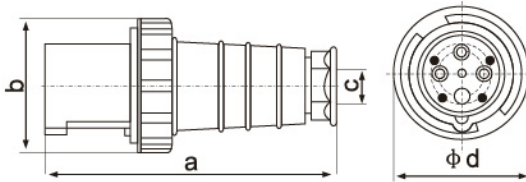

ปลั๊กตัวพู้

		P1-0342-6h	P1-0442-6h
Earth contact position		6h	
Rated current(A)		63	125
Pole		4	
Dimension(mm)	a	213.5	295
	b	110	123
	c	16-38	30-64
	ø	110	123
Cable nominal cross-section area(mm <sup>2</sup> )		6-16	16-50
Net Weight(PC)			
Packing		2/กล่อง 10/ลิ้น	1/กล่อง 10/ลิ้น
Price		<b>650.-</b>	<b>2,300.-</b>

Model:

■ P1-0352-6h

■ P1-0452-6h



380/415V  
3 สาย 5 ขา  
IP67



3P+N+E

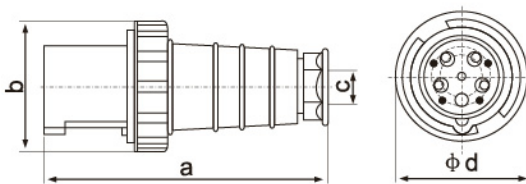

ปลั๊กตัวพู้

		P1-0352-6h	P1-0452-6h
Earth contact position		6h	
Rated current(A)		63	125
Pole		5	
Dimension(mm)	a	231.5	295
	b	110	123
	c	16-38	30-64
	ø	110	123
Cable nominal cross-section area(mm <sup>2</sup> )		6-16	16-50
Net Weight(PC)		670 g	
Packing		2/กล่อง 10/ลิ้น	2/กล่อง 10/ลิ้น
Price		<b>700.-</b>	<b>2,600.-</b>



โครงสร้างทั้งหมดผลิตจากเอ็นวีเนียริงพลาสติกที่ไม่ลามไฟ  
**FLAME RESISTANT ENGINEERING PLASTIC**

Model:

- P2-0332-6h
- P2-0432-6h



220/250V  
 2 สาย 3 ขา  
**IP67**



2P+E

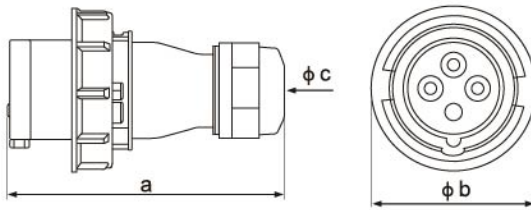

ปลั๊กตัวพู้

		P2-0332-6h	P2-0432-6h
Earth contact position		6h	
Rated current(A)		63	125
Pole		3	
Dimension(mm)	a	240	295
	b	115	126
	c	30	44.5
Cable nominal cross-section area(mm <sup>2</sup> )		6-16	16-50
Net Weight(PC)			
Packing		2/กล่อง 10/สีบ	1/กล่อง 10/สีบ
Price		<b>850.-</b>	<b>3,600.-</b>

Model:

- P2-0342-6h
- P2-0442-6h



380/415V  
 3 สาย 4 ขา  
**IP67**



3P+E

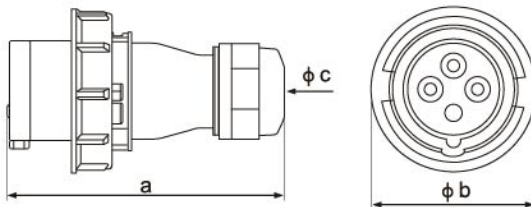

ปลั๊กตัวพู้

		P2-0342-6h	P2-0442-6h
Earth contact position		6h	
Rated current(A)		63	125
Pole		4	
Dimension(mm)	a	240	295
	b	115	126
	c	30	44.5
Cable nominal cross-section area(mm <sup>2</sup> )		6-16	16-50
Net Weight(PC)		700 g	
Packing		1/กล่อง 10/สีบ	2/กล่อง 10/สีบ
Price		<b>950.-</b>	<b>3,800.-</b>

Model:

- P2-0352-6h
- P2-0452-6h



380/415V  
 3 สาย 5 ขา  
**IP67**



3P+N+E

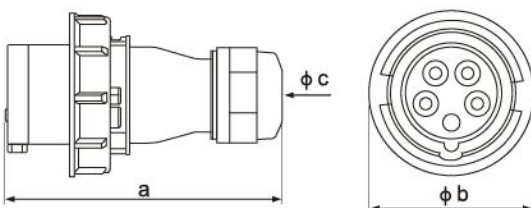

ปลั๊กตัวพู้

		P2-0352-6h	P2-0452-6h
Earth contact position		6h	
Rated current(A)		63	125
Pole		5	
Dimension(mm)	a	240	295
	b	115	126
	c	30	44.5
Cable nominal cross-section area(mm <sup>2</sup> )		6-16	16-50
Net Weight(PC)		780 g	
Packing		1/กล่อง 10/สีบ	1/กล่อง 10/สีบ
Price		<b>1,100.-</b>	<b>4,000.-</b>



โครงสร้างทั้งหมดผลิตจากเอ็นจิเนียริงพลาสติกที่ไม่ลามไฟ  
**FLAME RESISTANT ENGINEERING PLASTIC**

Model:

- P1-113-6h
- P1-123-6h



220/250V  
2 สาย 3 ขา  
IP44



2P+E

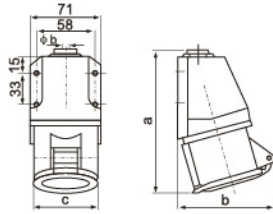

เต้ารับตัวเมียติดผนัง		P1-113-6h	P1-123-6h
Earth contact position		6h	
Rated current(A)		16	32
Pole		3	
Dimension(mm)	a	135	153
	b	92	102
	c	50	65
Cable nominal cross-section area(mm <sup>2</sup> )		1-2.5	2.5-6
Net Weight(PC)		198 g	
Packing		10/กล่อง 60/ลัง	10/กล่อง 60/ลัง
Price		<b>90.-</b>	<b>120.-</b>

Model:

- P1-114-6h
- P1-124-6h



380/415V  
3 สาย 4 ขา  
IP44



3P+E

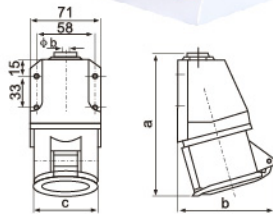

เต้ารับตัวเมียติดผนัง		P1-114-6h	P1-124-6h
Earth contact position		6h	
Rated current(A)		16	32
Pole		4	
Dimension(mm)	a	140	152
	b	95	140
	c	56	65
Cable nominal cross-section area(mm <sup>2</sup> )		1-2.5	2.5-6
Net Weight(PC)			227 g
Packing		10/กล่อง 60/ลัง	1/แพ็ค, 10/กล่อง 60/ลัง
Price		<b>100.-</b>	<b>130.-</b>

Model:

- P1-115-6h
- P1-125-6h



380/415V  
3 สาย 5 ขา  
IP44



3P+N+E

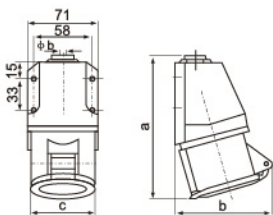

เต้ารับตัวเมียติดผนัง		P1-115-6h	P1-125-6h
Earth contact position		6h	
Rated current(A)		16	32
Pole		5	
Dimension(mm)	a	139	153
	b	96	107
	c	63	70
Cable nominal cross-section area(mm <sup>2</sup> )		1-2.5	2.5-6
Net Weight(PC)		225 g	225 g
Packing		1/แพ็ค, 10/กล่อง 60/ลัง	1/แพ็ค, 10/กล่อง 60/ลัง
Price		<b>115.-</b>	<b>150.-</b>

▶ =สินค้าพร้อมเดอร



โครงสร้างทั้งหมดผลิตจากเอ็นจิเนียริงพลาสติกที่ไม่ลามไฟ  
**FLAME RESISTANT ENGINEERING PLASTIC**

- Model:  
▶ P2-1131-6h  
▶ P2-1231-6h



220/250V  
2 สาย 3 ขา  
IP55



2P+E

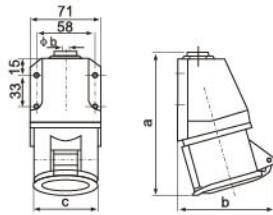

เต้ารับตัวเมียติดผนัง		P2-1131-6h	P2-1231-6h
Earth contact position		6h	
Rated current(A)		16	32
Pole		3	
Dimension(mm)	a	135	153
	b	92	102
	c	50	65
Cable nominal cross-section area(mm <sup>2</sup> )		1-2.5	2.5-6
Packing			
Price			

- Model:  
▶ P2-1141-6h  
▶ P2-1241-6h



380/415V  
3 สาย 4 ขา  
IP55



3P+E

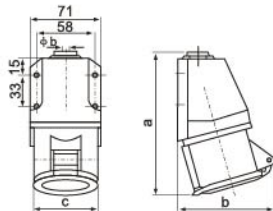

เต้ารับตัวเมียติดผนัง		P2-1141-6h	P2-1241-6h
Earth contact position		6h	
Rated current(A)		16	32
Pole		4	
Dimension(mm)	a	140	152
	b	95	140
	c	56	65
Cable nominal cross-section area(mm <sup>2</sup> )		1-2.5	2.5-6
Packing			
Price			

- Model:  
▶ P2-1151-6h  
▶ P2-1251-6h



380/415V  
3 สาย 5 ขา  
IP55



3P+N+E

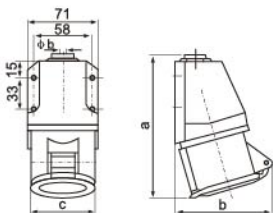

เต้ารับตัวเมียติดผนัง		P2-1151-6h	P2-1251-6h
Earth contact position		6h	
Rated current(A)		16	32
Pole		5	
Dimension(mm)	a	139	153
	b	96	107
	c	63	70
Cable nominal cross-section area(mm <sup>2</sup> )		1-2.5	2.5-6
Packing			
Price			



โครงสร้างทั้งหมดผลิตจากเอ็นจิเนียริงพลาสติกที่ไม่ลามไฟ  
**FLAME RESISTANT ENGINEERING PLASTIC**

Model:

- P2-1132-6h
- P2-1232-6h



220/250V  
 2 สาย 3 ขา  
 IP67



2P+E

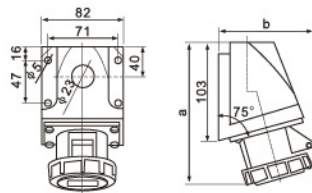

ตัวรับตัวเมียติดผนัง		P2-1132-6h	P2-1232-6h
Earth contact position		6h	
Rated current(A)		16	32
Pole		3	
Dimension(mm)	a	155	170
	b	99	108
Cable nominal cross-section area(mm <sup>2</sup> )		1-2.5	2.5-6
Packing		10/กล่อง 60/ตู้	10/กล่อง 60/ตู้
Price		<b>175.-</b>	<b>200.-</b>

Model:

- P2-1142-6h
- P2-1242-6h



380/415V  
 3 สาย 4 ขา

IP67



3P+E

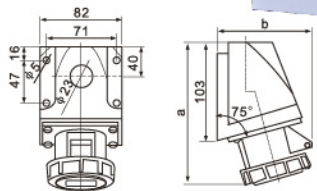

ตัวรับตัวเมียติดผนัง		P2-1142-6h	P2-1242-6h
Earth contact position		6h	
Rated current(A)		16	32
Pole		4	
Dimension(mm)	a	155	170
	b	101	108
Cable nominal cross-section area(mm <sup>2</sup> )		1-2.5	2.5-6
Packing		10/กล่อง 60/ตู้	10/กล่อง 60/ตู้
Price		<b>170.-</b>	<b>220.-</b>

Model:

- P2-1152-6h
- P2-1252-6h



380/415V  
 3 สาย 5 ขา

IP67



3P+N+E

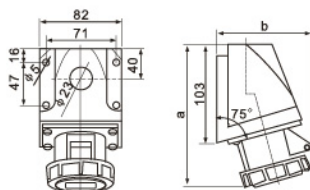

ตัวรับตัวเมียติดผนัง		P2-1152-6h	P2-1252-6h
Earth contact position		6h	
Rated current(A)		16	32
Pole		5	
Dimension(mm)	a	155	172
	b	106	111
Cable nominal cross-section area(mm <sup>2</sup> )		1-2.5	2.5-6
Packing		10/กล่อง 60/ตู้	10/กล่อง 60/ตู้
Price		<b>200.-</b>	<b>250.-</b>



โครงสร้างทั้งหมดผลิตจากเอ็นจิเนียริ่งพลาสติกที่ไม่ลามไฟ  
**FLAME RESISTANT ENGINEERING PLASTIC**

Model:

- P2-1332-6h
- P2-1432-6h



220/250V  
 2 สาย 3 ขา

IP67



2P+E

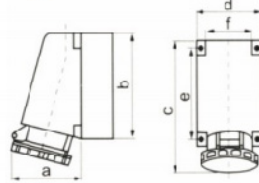

ตัวรับตัวเมียติดผนัง		P2-1332-6h	P2-1432-6h
Earth contact position		6h	
Rated current(A)		63	125
Pole		3	
Dimension(mm)	a	171	220
	b	170	220
	c	250	285
	d	118	140
	e	137	185
	f	104	130
Cable nominal cross-section area(mm <sup>2</sup> )		6-16	16-50
Packing		1/กล่อง 10/สับ	1/กล่อง 10/สับ
Price		<b>950.-</b>	<b>2,800.-</b>

Model:

- P2-1342-6h
- P2-1442-6h



380/415V  
 3 สาย 4 ขา

IP67



3P+E

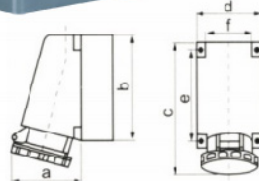

ตัวรับตัวเมียติดผนัง		P2-1342-6h	P2-1442-6h
Earth contact position		6h	
Rated current(A)		63	125
Pole		4	
Dimension(mm)	a	171	220
	b	170	220
	c	250	285
	d	118	140
	e	137	185
	f	104	130
Cable nominal cross-section area(mm <sup>2</sup> )		6-16	16-50
Packing		1/กล่อง 10/สับ	1/กล่อง 10/สับ
Price		<b>1,000.-</b>	<b>2,900.-</b>

Model:

- P2-1352-6h
- P2-1452-6h



380/415V  
 3 สาย 5 ขา

IP67



3P+N+E

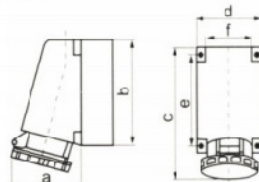

ตัวรับตัวเมียติดผนัง		P2-1352-6h	P2-1452-6h
Earth contact position		6h	
Rated current(A)		63	125
Pole		5	
Dimension(mm)	a	171	220
	b	170	220
	c	250	285
	d	118	140
	e	137	185
	f	104	130
Cable nominal cross-section area(mm <sup>2</sup> )		6-16	16-50
Packing		1/กล่อง 10/สับ	1/กล่อง 10/สับ
Price		<b>1,050.-</b>	<b>3,000.-</b>



โครงสร้างทั้งหมดผลิตจากเอ็นวีเนียริงพลาสติกที่ไม่ลามไฟ  
**FLAME RESISTANT ENGINEERING PLASTIC**

Model:

- P1-213-6h
- P1-223-6h



220/250V  
2 สาย 3 ขา

IP44



2P+E

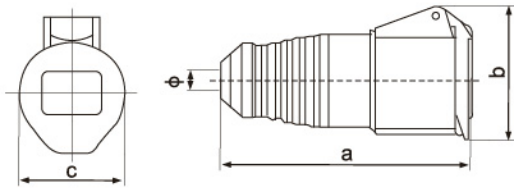

ตัวรับตัวเมียต่อกกลาง		P1-213-6h	P1-223-6h
Earth contact position		6h	
Rated current(A)		16	32
	Pole	3	
Dimension(mm)	a	131	152
	b	69	94
	c	50.5	65
	ø	6	8
Cable nominal cross-section area(mm <sup>2</sup> )		1-2.5	2.5-6
Net Weight(PC)		114 g	199 g
Packing		1/แพ็ค, 10/กล่อง 100/ลัง	1/แพ็ค, 10/กล่อง 60/ลัง
Price		<b>75.-</b>	<b>155.-</b>

Model:

- P1-214-6h
- P1-224-6h



380/415V  
3 สาย 4 ขา

IP44



3P+E

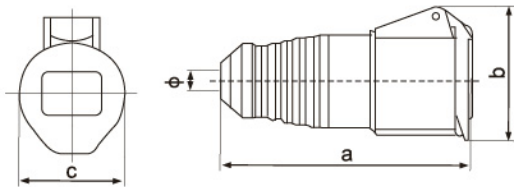

ตัวรับตัวเมียต่อกกลาง		P1-214-6h	P1-224-6h
Earth contact position		6h	
Rated current(A)		16	32
	Pole	4	
Dimension(mm)	a	131	152
	b	79	94
	c	56	65
	ø	6	8
Cable nominal cross-section area(mm <sup>2</sup> )		1-2.5	2.5-6
Net Weight(PC)			220 g
Packing		10/กล่อง 100/ลัง	10/กล่อง 60/ลัง
Price		<b>120.-</b>	<b>170.-</b>

Model:

- P1-215-6h
- P1-225-6h



380/415V  
3 สาย 5 ขา

IP44



3P+N+E

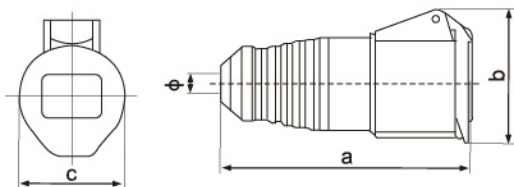

ตัวรับตัวเมียต่อกกลาง		P1-215-6h	P1-225-6h
Earth contact position		6h	
Rated current(A)		16	32
	Pole	5	
Dimension(mm)	a	141	154
	b	93	101
	c	64	71
	ø	8	8
Cable nominal cross-section area(mm <sup>2</sup> )		1-2.5	2.5-6
Net Weight(PC)		181 g	250 g
Packing		1/แพ็ค, 10/กล่อง 60/ลัง	10/กล่อง 60/ลัง
Price		<b>145.-</b>	<b>195.-</b>



โครงสร้างทั้งหมดผลิตจากเอ็นวีเนียริงพลาสติกที่ไม่ลามไฟ  
**FLAME RESISTANT ENGINEERING PLASTIC**

Model:

- P2-2131-6h
- P2-2231-6h



220/250V  
2 สาย 3 ขา

IP55



2P+E

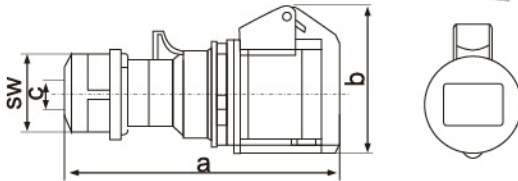

ตัวรับตัวเมียต่อกกลาง		P2-2131-6h	P2-2231-6h
Earth contact position		6h	
Rated current(A)		16	32
Pole		3	
Dimension(mm)	a	127	159
	b	75	90
	c	6-15	10-20
	sw	38	50
Cable nominal cross-section area(mm <sup>2</sup> )		1-2.5	2.5-6
Net Weight(PC)		340 g	
Packing		10/กล่อง 60/สับ	1/แพ็คเกจ, 10/กล่อง 60/สับ
Price		<b>115.-</b>	<b>265.-</b>

Model:

- P2-2141-6h
- P2-2241-6h



380/415V  
3 สาย 4 ขา

IP55



3P+E

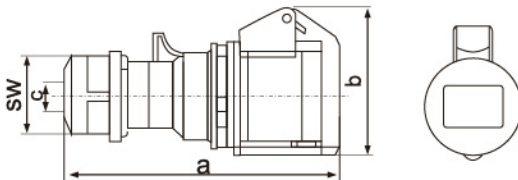

ตัวรับตัวเมียต่อกกลาง		P2-2141-6h	P2-2241-6h
Earth contact position		6h	
Rated current(A)		16	32
Pole		4	
Dimension(mm)	a	135	159
	b	80	90
	c	6-15	10-20
	sw	38	50
Cable nominal cross-section area(mm <sup>2</sup> )		1-2.5	2.5-6
Net Weight(PC)			
Packing			
Price		<b>195.-</b>	<b>175.-</b>

Model:

- P2-2151-6h
- P2-2251-6h



380/415V  
3 สาย 5 ขา

IP55



3P+N+E

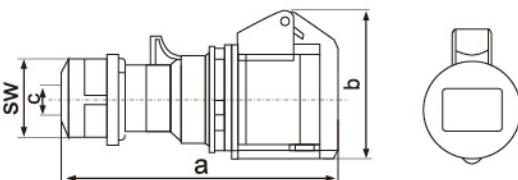

ตัวรับตัวเมียต่อกกลาง		P2-2151-6h	P2-2251-6h
Earth contact position		6h	
Rated current(A)		16	32
Pole		5	
Dimension(mm)	a	142	159
	b	82	97
	c	8-16	10-20
	sw	42	50
Cable nominal cross-section area(mm <sup>2</sup> )		1-2.5	2.5-6
Net Weight(PC)			
Packing			
Price			





โครงสร้างทั้งหมดผลิตจากเอ็นวีเนียริงพลาสติกที่ไม่ลามไฟ  
**FLAME RESISTANT ENGINEERING PLASTIC**

Model:

- P2-2132-6h
- P2-2232-6h



220/250V  
2 สาย 3 ขา  
IP67



2P+E

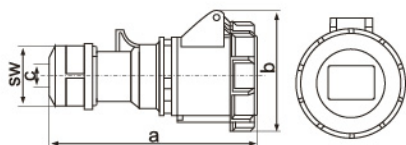

ตัวรับตัวเมียต่อกกลาง		P2-2132-6h	P2-2232-6h
Earth contact position		6h	
Rated current(A)		16	32
	Pole	3	
Dimension(mm)	a	130	163
	b	71	97
	c	6-15	10-20
	sw	38	50
Cable nominal cross-section area(mm <sup>2</sup> )		1-2.5	2.5-6
Net Weight(PC)			233 g
Packing		10/กล่อง 60/ลัง	10/กล่อง 60/ลัง
Price		<b>130.-</b>	<b>190.-</b>

Model:

- P2-2142-6h
- P2-2242-6h



380/415V  
3 สาย 4 ขา  
IP67



3P+E

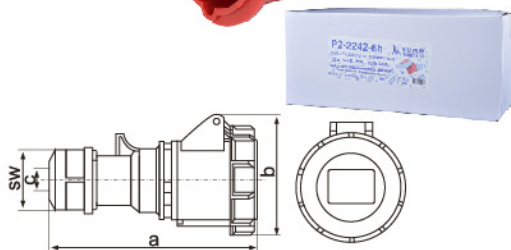

ตัวรับตัวเมียต่อกกลาง		P2-2142-6h	P2-2242-6h
Earth contact position		6h	
Rated current(A)		16	32
	Pole	4	
Dimension(mm)	a	138	163
	b	87	97
	c	6-15	10-20
	sw	38	50
Cable nominal cross-section area(mm <sup>2</sup> )		1-2.5	2.5-6
Net Weight(PC)			241 g
Packing		10/กล่อง 60/ลัง	1/แพ็คเกจ, 10/กล่อง 60/ลัง
Price		<b>150.-</b>	<b>200.-</b>

Model:

- P2-2152-6h
- P2-2252-6h



380/415V  
3 สาย 5 ขา  
IP67



3P+N+E

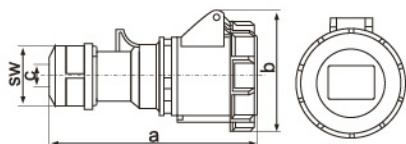

ตัวรับตัวเมียต่อกกลาง		P2-2152-6h	P2-2252-6h
Earth contact position		6h	
Rated current(A)		16	32
	Pole	5	
Dimension(mm)	a	145	168
	b	93	104
	c	8-16	12-22
	sw	42	50
Cable nominal cross-section area(mm <sup>2</sup> )		1-2.5	2.5-6
Net Weight(PC)			
Packing		10/กล่อง 60/ลัง	10/กล่อง 60/ลัง
Price		<b>170.-</b>	<b>220.-</b>

▶ =สินค้าพร้อมเดอร



โครงสร้างทั้งหมดผลิตจากเอ็นวีเนียริงพลาสติกที่ไม่ลามไฟ  
**FLAME RESISTANT ENGINEERING PLASTIC**

Model:

- P1-2332-6h
- ▶ P1-2432-6h



220/250V  
2 สาย 3 ขา

IP67



2P+E

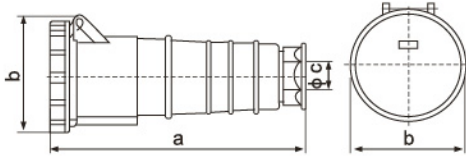

ตัวรับตัวเมียต่อกกลาง	P1-2332-6h	P1-2432-6h
Earth contact position	6h	
Rated current(A)	63	125
Pole	3	
Dimension(mm)	a	240
	b	115
	c	16-38
	ø	108
Cable nominal cross-section area(mm <sup>2</sup> )	6 - 16	16 - 50
Net Weight(PC)		
Packing	1 ชิ้น/กล่อง 10 ชิ้น/ลัง	1 ชิ้น/กล่อง 10 ชิ้น/ลัง
Price	<b>880.-</b>	<b>2,400.-</b>

Model:

- P1-2342-6h
- ▶ P1-2442-6h



380/415V  
3 สาย 4 ขา

IP67



3P+E

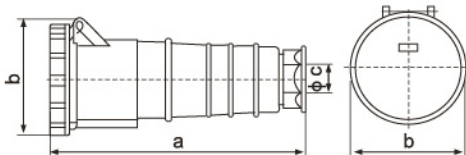

ตัวรับตัวเมียต่อกกลาง	P1-2342-6h	P1-2442-6h
Earth contact position	6h	
Rated current(A)	63	125
Pole	4	
Dimension(mm)	a	240
	b	115
	c	16-38
	ø	108
Cable nominal cross-section area(mm <sup>2</sup> )	6 - 16	16 - 50
Net Weight(PC)	950 g	
Packing	2 ชิ้น/กล่อง 10 ชิ้น/ลัง	1 ชิ้น/กล่อง 10 ชิ้น/ลัง
Price	<b>950.-</b>	<b>2,500.-</b>

Model:

- P1-2352-6h
- ▶ P1-2452-6h



380/415V  
3 สาย 5 ขา

IP67



3P+N+E

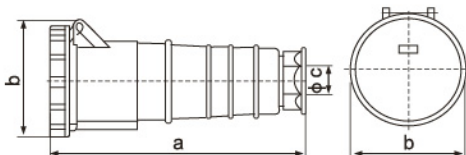

ตัวรับตัวเมียต่อกกลาง	P1-2352-6h	P1-2452-6h
Earth contact position	6h	
Rated current(A)	63	125
Pole	5	
Dimension(mm)	a	240
	b	115
	c	16-38
	ø	108
Cable nominal cross-section area(mm <sup>2</sup> )	6-16	16-50
Net Weight(PC)	900 g	
Packing	1 ชิ้น/กล่อง 10 ชิ้น/ลัง	1 ชิ้น/กล่อง 10 ชิ้น/ลัง
Price	<b>1,050.-</b>	<b>2,650.-</b>



โครงสร้างทั้งหมดผลิตจากเอ็นวีเนียริงพลาสติกที่ไม่ลามไฟ  
**FLAME RESISTANT ENGINEERING PLASTIC**

Model:

- P2-2332-6h
- P2-2432-6h



220/250V  
2 สาย 3 ขา  
IP67



2P+E

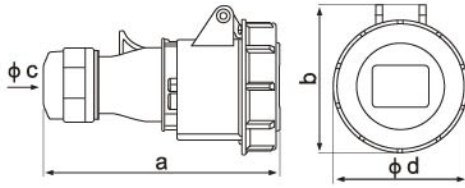

ตัวรับตัวเมียต่อกลาง	P2-2332-6h	P2-2432-6h
Earth contact position	6h	
Rated current(A)	63	125
Pole	3	
Dimension(mm)	a	261
	b	114
	c	30
	d	112
Cable nominal cross-section area(mm <sup>2</sup> )	6 - 16	16 - 50
Packing	1/กล่อง 10/สับ	1/กล่อง 10/สับ
Price	<b>1,100.-</b>	<b>3,700.-</b>

Model:

- P2-2342-6h
- P2-2442-6h



380/415V  
3 สาย 4 ขา  
IP67



3P+E

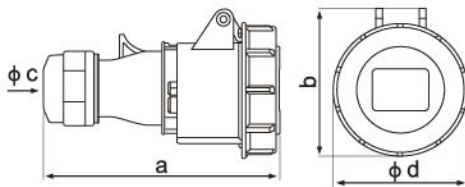

ตัวรับตัวเมียต่อกลาง	P2-2342-6h	P2-2442-6h
Earth contact position	6h	
Rated current(A)	63	125
Pole	4	
Dimension(mm)	a	261
	b	114
	c	30
	d	112
Cable nominal cross-section area(mm <sup>2</sup> )	6 - 16	16 - 50
Packing	1/กล่อง 10/สับ	1/กล่อง 10/สับ
Price	<b>1,200.-</b>	<b>3,900.-</b>

Model:

- P2-2352-6h
- P2-2452-6h



380/415V  
3 สาย 5 ขา  
IP67



3P+N+E

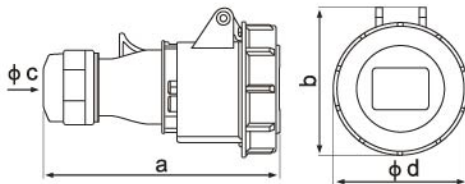

ตัวรับตัวเมียต่อกลาง	P2-2352-6h	P2-2452-6h
Earth contact position	6h	
Rated current(A)	63	125
Pole	5	
Dimension(mm)	a	261
	b	114
	c	30
	d	112
Cable nominal cross-section area(mm <sup>2</sup> )	6-16	16-50
Packing	1/กล่อง 10/สับ	1/กล่อง 10/สับ
Price	<b>1,300.-</b>	<b>4,100.-</b>



โครงสร้างทั้งหมดผลิตจากเอ็นอีเมียร์พลาสติกที่ไม่ลามไฟ  
**FLAME RESISTANT ENGINEERING PLASTIC**

Model:

- P1-413-6h
- P1-423-6h



220/250V  
2 สาย 3 ขา  
IP44



2P+E

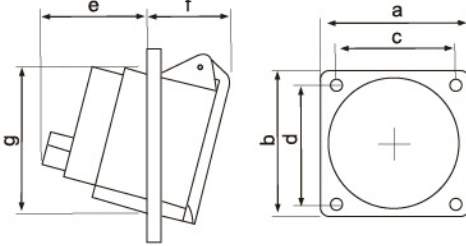

ตัวรับติดผนังเฉียง	P1-413-6h	P1-423-6h
Earth contact position	6h	
Rated current(A)	16	32
Pole	3	
Dimension(mm)	a	80
	b	96
	c	60
	d	70
	e	42
	f	43
	g	75
Cable nominal cross-section area(mm <sup>2</sup> )	1-2.5	2.5-6
Net Weight(PC)	95 g	
Packing	10/กล่อง 60/ลิ้น	10/กล่อง 60/ลิ้น
Price	<b>75.-</b>	<b>100.-</b>

Model:

- P1-414-6h
- P1-424-6h



380/415V  
3 สาย 4 ขา  
IP44



3P+E

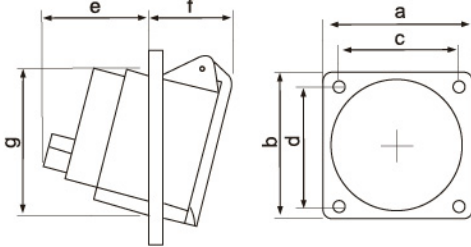

ตัวรับติดผนังเฉียง	P1-414-6h	P1-424-6h
Earth contact position	6h	
Rated current(A)	16	32
Pole	4	
Dimension(mm)	a	80
	b	96
	c	60
	d	70
	e	42
	f	43
	g	75
Cable nominal cross-section area(mm <sup>2</sup> )	1-2.5	2.5-6
Net Weight(PC)		
Packing	10/กล่อง 60/ลิ้น	10/กล่อง 60/ลิ้น
Price	<b>85.-</b>	<b>115.-</b>

Model:

- P1-415-6h
- P1-425-6h



380/415V  
3 สาย 5 ขา  
IP44



3P+N+E

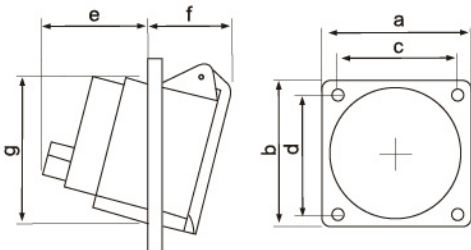

ตัวรับติดผนังเฉียง	P1-415-6h	P1-425-6h
Earth contact position	6h	
Rated current(A)	16	32
Pole	5	
Dimension(mm)	a	82
	b	97
	c	60
	d	70
	e	42
	f	47
	g	81
Cable nominal cross-section area(mm <sup>2</sup> )	1-2.5	2.5-6
Net Weight(PC)	175 g	
Packing	10/กล่อง 60/ลิ้น	
Price	<b>98.-</b>	<b>130.-</b>

▶ = สิ้นค้าพร้อมต่อ



โครงสร้างทั้งหมดผลิตจากเอ็นจิเนียริงพลาสติกที่ไม่ลามไฟ  
**FLAME RESISTANT ENGINEERING PLASTIC**

Model:

- ▶ P1-313-6h
- ▶ P1-323-6h



220/250V  
2 สาย 3 ขา  
IP44



2P+E

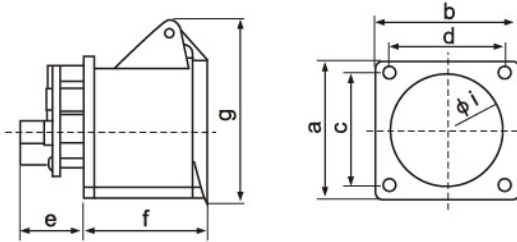

ตัวรับตัวเมียติดผนังตรง		P1-313-6h	P1-323-6h
Earth contact position		6h	
Rated current(A)		16	32
	Pole	3	
Dimension(mm)	a	69.5	71
	b	69.5	71
	c	56	56
	d	56	56
	e	28	28
	f	48	63
	g	70	88
	h	52	56
	Cable nominal cross-section area(mm <sup>2</sup> )		1-2.5
Net Weight(PC)			158 g
Packing		10/กล่อง, 60/ลิ้ง	10/กล่อง, 60/ลิ้ง
Price		<b>70.-</b>	<b>95.-</b>

Model:

- ▶ P1-314-6h
- ▶ P1-324-6h



380/415V  
3 สาย 4 ขา  
IP44



3P+E

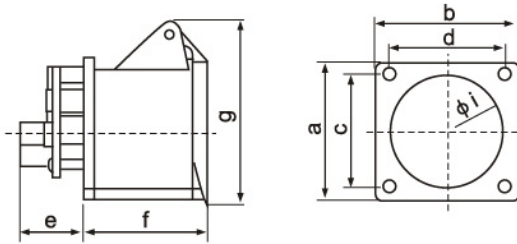

ตัวรับตัวเมียติดผนังตรง		P1-314-6h	P1-324-6h
Earth contact position		6h	
Rated current(A)		16	32
	Pole	4	
Dimension(mm)	a	70	71
	b	70	71
	c	56	56
	d	56	56
	e	28	28
	f	51	63
	g	80	88
	h	56	56
	Cable nominal cross-section area(mm <sup>2</sup> )		1-2.5
Net Weight(PC)			
Packing			
Price			

Model:

- ▶ P1-315-6h
- ▶ P1-325-6h



380/415V  
3 สาย 5 ขา  
IP44



3P+N+E

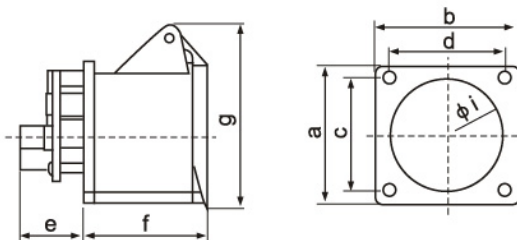

ตัวรับตัวเมียติดผนังตรง		P1-315-6h	P1-325-6h
Earth contact position		6h	
Rated current(A)		16	32
	Pole	5	
Dimension(mm)	a	70	71
	b	70	71
	c	56	56
	d	56	56
	e	28	33
	f	52	63
	g	86	95
	h	56	56
	Cable nominal cross-section area(mm <sup>2</sup> )		
Net Weight(PC)			
Packing			
Price			

▶ สีน้ำตาลกำลังเข้า  มีสีน้ำตาล



โครงสร้างทั้งหมดผลิตจากเอ็นอีเอวีเออร์พลาสติกที่ไม่ลามไฟ  
**FLAME RESISTANT ENGINEERING PLASTIC**

Model:

- P2-4132-6h
- P2-4232-6h



220/250V  
2 สาย 3 ขา  
IP67



2P+E

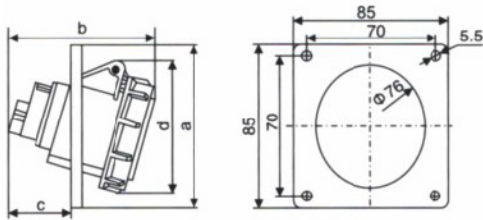

ตัวรับติดผนังเฉียง

	P2-4132-6h	P2-4232-6h
Earth contact position	6h	
Rated current(A)	16	32
Pole	3	
Dimension(mm)	a	85
	b	90
	c	41
	d	77
Cable nominal cross-section area(mm <sup>2</sup> )	1-2.5	2.5-6
Packing	10/กล่อง 60/ลัง	10/กล่อง 60/ลัง
Price	<b>200.-</b>	<b>280.-</b>

Model:

- ▶ P2-4142-6h
- P2-4242-6h

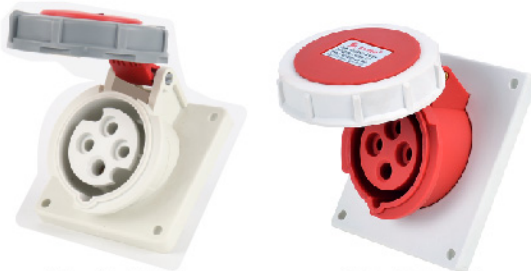

▶ P2-4142-6h

P2-4242-6h

380/415V  
3 สาย 4 ขา



3P+E

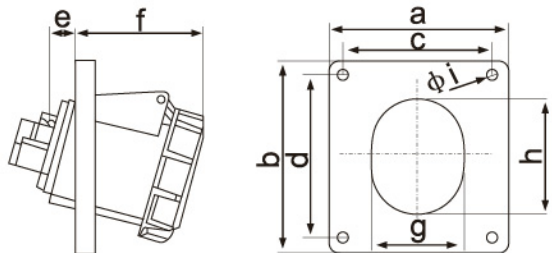

ตัวรับติดผนังเฉียง

	P2-4142-6h	P2-4242-6h
Earth contact position	6h	
Rated current(A)	16	32
Pole	4	
Dimension(mm)	a	93
	b	102
	c	78
	d	86
	e	33
	f	40
	g	52
	h	70
	i	77
		83
		5.5
Cable nominal cross-section area(mm <sup>2</sup> )	1-2.5	2.5-6
Packing	10/กล่อง, 60/ลัง	10/กล่อง, 60/ลัง
Weight/Pc	165 g	
Price	<b>220.-</b>	<b>285.-</b>

Model:

- P2-4152-6h
- P2-4252-6h



380/415V  
3 สาย 5 ขา



3P+N+E

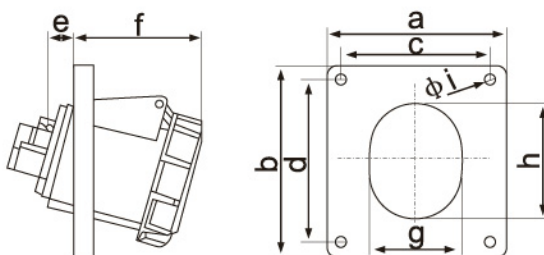

ตัวรับติดผนังเฉียง

	P2-4152-6h	P2-4252-6h
Earth contact position	6h	
Rated current(A)	16	32
Pole	5	
Dimension(mm)	a	93
	b	102
	c	78
	d	86
	e	36
	f	41
	g	52
	h	70
		78
		83
		5.5
Cable nominal cross-section area(mm <sup>2</sup> )	1-2.5	2.5-6
Packing	10/กล่อง 60/ลัง	10/กล่อง 60/ลัง
Price	<b>235.-</b>	<b>295.-</b>



โครงสร้างทั้งหมดผลิตจากเอ็นวีเนียริงพลาสติกที่ไม่ลามไฟ  
**FLAME RESISTANT ENGINEERING PLASTIC**

Model:  
**P1-0123**



220/250V  
 2 สาย 2 ขา  
**IP44**

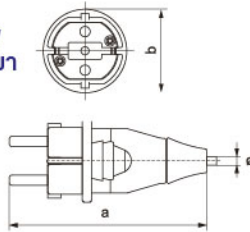

Model:  
**P1-0123TH**



220/250V  
 3 สาย 3 ขา  
**IP44**

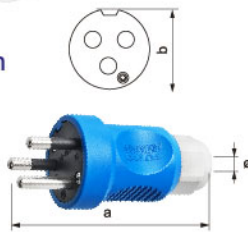

### ปลั๊กตัวผู้

		P1-0123	P1-0123TH
Earth contact position		<b>6h</b>	<b>6h</b>
	Rated current(A)	16	16
Pole		2	3
	Dimension(mm)		
a		97	85
	b	37	36
	ø	6	9
Cable nominal cross-section area(mm <sup>2</sup> )		1-2.5	1-2.5
Packing		20/กล่อง,200/ลัง	10/กล่อง,200/ลัง
Price		<b>45.-</b>	<b>72.-</b>

Model:  
**P1-1123**



220/250V  
 2 สาย 2 ขา  
**IP54**

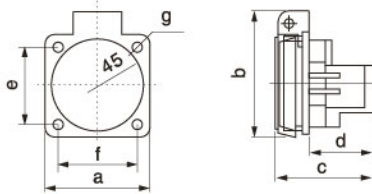

### เต้ารับตัวเมียติดผนัง

### P1-1123

Earth contact position		<b>6h</b>
	Rated current(A)	16
Pole		2
	Dimension(mm)	
a		50.6
	b	65
	c	42
	d	27
	e	38.2
	f	38.2
	g	4.5
Cable nominal cross-section area(mm <sup>2</sup> )		1-2.5
Packing		20/กล่อง,200/ลัง
Price		<b>45.-</b>

Model:  
**P1-2123**



220/250V  
 2 สาย 2 ขา  
**IP44**

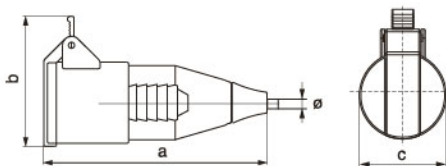

### เต้ารับตัวเมียต่อกกลาง

### P1-2123

Earth contact position		-
	Rated current(A)	16
Pole		3
	Dimension(mm)	
a		97
	b	37
	ø	6
Cable nominal cross-section area(m)		1-2.5
Packing		10/กล่อง,100/ลัง
Price		<b>70.-</b>



โครงสร้างทั้งหมดผลิตจากเอ็นจิเนียริ่งพลาสติกที่ไม่ลามไฟ  
**FLAME RESISTANT ENGINEERING PLASTIC**

Model:

■ **P1-1123R**

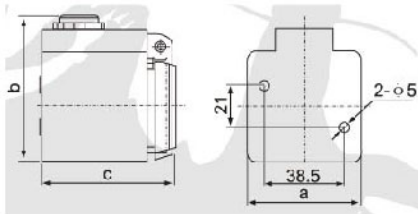

220/250V  
2 สาย 3 ขา  
**IP44**



ตัวรับตัวเมีย		<b>P1-1123R</b>
Earth contact position		6h
Rated current(A)		16
	Pole	2
Dimension (mm)	a	53.6
	b	72
	c	63.5
Cable nominal cross-section area (mm <sup>2</sup> )		1-2.5
Packing		10/กล่อง 100/ลิ้น
Price		<b>70.-</b>

Model:

■ **P1-313U (UNIVERSAL TYPE)**

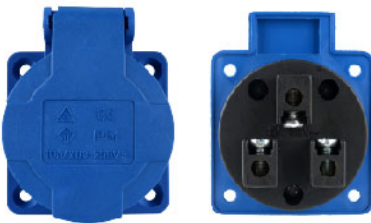

220/250V  
2 สาย 3 ขา  
**IP44**



ตัวรับตัวเมีย		<b>P1-313U</b>
Earth contact position		-
Rated current(A)	Plug	-
	Socket	16
	Pole	3
Dimension (mm)	a	50
	b	50
	c	64
	d	43
Cable nominal cross-section area (mm <sup>2</sup> )		-
Packing		20/กล่อง 200/ลิ้น
Price		<b>65.-</b>

Model:

■ **P1-313TH (THAI TYPE)**

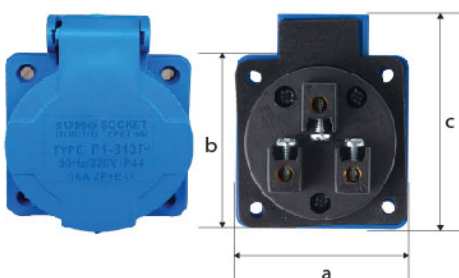

220/250V  
2 สาย 3 ขา  
**IP44**

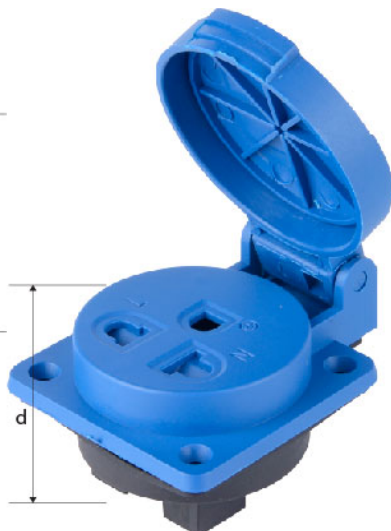

ตัวรับตัวเมีย		<b>P1-313TH</b>
Earth contact position		-
Rated current(A)	Plug	-
	Socket	16
	Pole	3
Dimension (mm)	a	50
	b	50
	c	64
	d	43
Cable nominal cross-section area (mm <sup>2</sup> )		-
Packing		10/กล่อง 200/ลิ้น
Price		<b>72.-</b>





โครงสร้างทั้งหมดผลิตจากเอ็นจิเนียริงพลาสติกที่ไม่ลามไฟ  
**FLAME RESISTANT ENGINEERING PLASTIC**

Model:

■ **P1-012Y**

220/250V  
 2 สาย 3 ขา

IP44



2P+E



ปลั๊กและเต้ารับ	P1-012Y	---
Earth contact position	6h	
Rated current(A)	Plug	16
	Socket	16
	Pole	3
Dimension(mm)		
Cable nominal cross-section area(mm <sup>2</sup> )	1-2.5	2.5-6
Net Weight(PC)	350 g	
Packing	1/แพ็ค 5/กล่อง, 20/ลัง	
Price	<b>315.-</b>	

Model:

■ **P1-013Y**

220/250V  
 2 สาย 3 ขา

IP44



2P+E

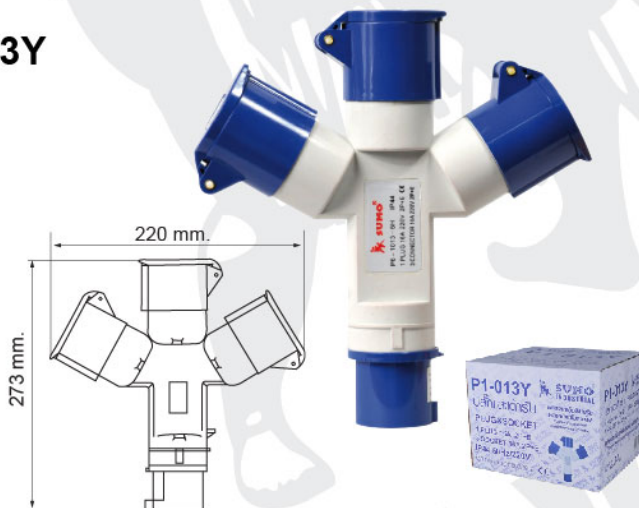

ปลั๊กและเต้ารับ	P1-013Y	
Earth contact position	6h	
Rated current(A)	Plug	16
	Socket	16
	Pole	3
Dimension(mm)		
Cable nominal cross-section area(mm <sup>2</sup> )		
Net Weight(PC)	467 g	
Packing	1/แพ็ค 5/กล่อง, 20/ลัง	
Price	<b>400.-</b>	

Model:

■ **P1-023Y**

220/250V  
 2 สาย 3 ขา

IP44



2P+E

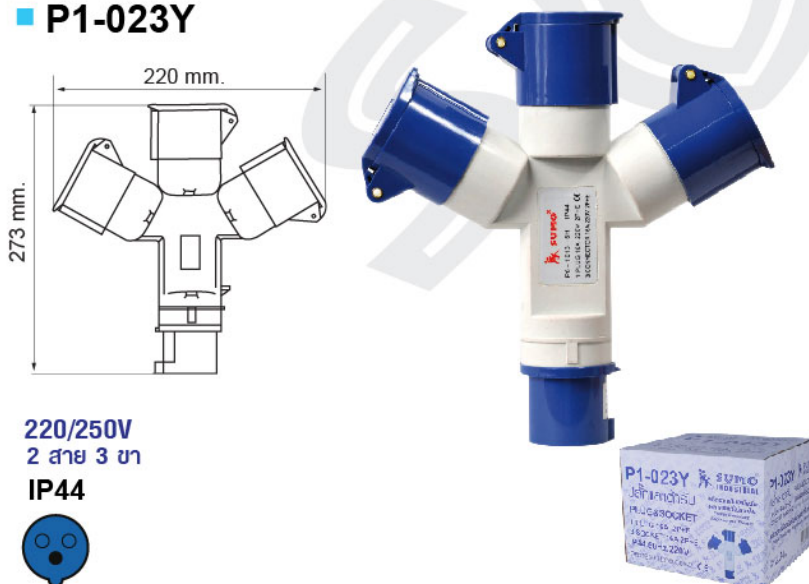

ปลั๊กและเต้ารับ	P1-023Y	P1-053Y
Earth contact position	6h	
Rated current(A)	Plug	32
	Socket	32
	Pole	3
Dimension(mm)		
Cable nominal cross-section area(mm <sup>2</sup> )		
Net Weight(PC)	840 g	474 g
Packing	4/กล่อง, 20/ลัง	4/กล่อง, 20/ลัง
Price	<b>950.-</b>	<b>1,200.-</b>

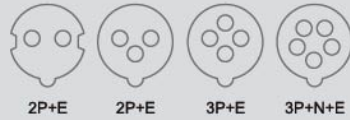

# ■ P1-053Y

**220/250V**  
**2 สาย 3 ขา**  
**IP44**



2P+E

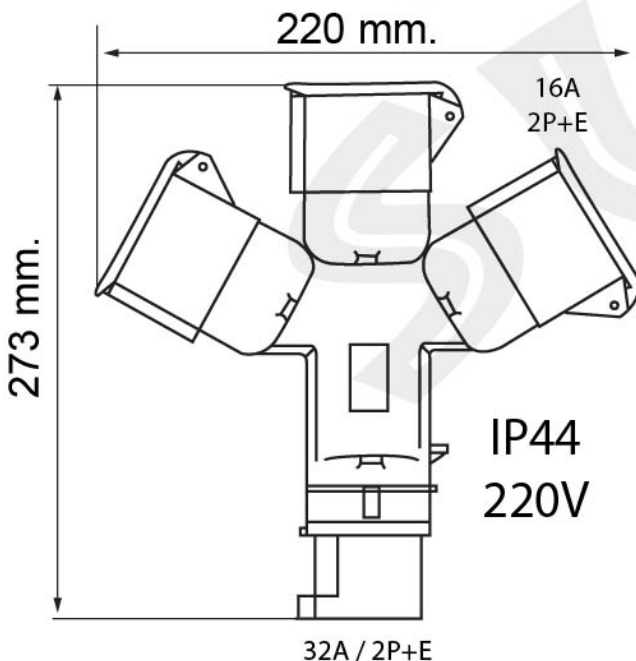

## ปลั๊กและเต้ารับ

## P1-053Y

Earth contact position	6h	
Rated current(A)	Plug	32
	Socket	16
	Pole	3
Dimension(mm)		
Cable nominal cross-section area(mm <sup>2</sup> )		
Packing	5/กล่อง, 20/ลัง	
Lot		
Price	<b>1,200.-</b>	



Model:

- P1-113Z
- P1-123Z



220/250V  
2 สาย 3 ขา  
IP44



2P+E

เต้ารับตัวเมียพร้อมสวิตช์	P1-113Z	P1-123Z
Earth contact position	6h	
Rated current(A)	16	32
Pole	3	
Dimension(mm)		
Cable nominal cross-section area(mm <sup>2</sup> )		
Packing	1/กล่อง 50/กล่อง	1/กล่อง 50/กล่อง
Price	<b>960.-</b>	<b>1,100.-</b>

Model:

- P1-114Z
- P1-124Z



380/415V  
3 สาย 4 ขา  
IP44



3P+E

เต้ารับตัวเมียพร้อมสวิตช์	P1-114Z	P1-124Z
Earth contact position	6h	
Rated current(A)	16	32
Pole	4	
Dimension(mm)		
Cable nominal cross-section area(mm <sup>2</sup> )		
Packing	1/กล่อง 50/กล่อง	1/กล่อง 50/กล่อง
Price	<b>1,050.-</b>	<b>1,150.-</b>



โครงสร้างทั้งหมดผลิตจากเอ็นอีเอวีริงพลาสติกที่ไม่ลามไฟ  
**FLAME RESISTANT ENGINEERING PLASTIC**

### SUMO CEE/IEC International Standard Mobile Power Socket Box

Conform to European / international standards EN/IEC 60309-2

ISO9001 ISO14001 OHSAS18001



#### EARTH LEAKAGE CIRCUIT BREAKER

Earth leakage circuit breaker is used for the protection against electrical leakage in the circuit of 50Hz or 60Hz, rated voltage single-phase 240V, 3-phase 415V, rated current up to 60A. When somebody gets an electric shock or the residual current of the circuit exceeds the fixed value, the ELCB can cut off the power within the time of 0.1s automatically protecting the personal safety and preventing the equipment from the fault resulted from the residual current. With this function, the ELCB can protect the circuit against overload and short circuit or can be used for the unfrequent switchover of the circuit under normal conditions. It conforms to IEC61009 standard.

**Rated Operating Current  $1\Delta n = 30mA$**

**Leakage action time  $\leq 0.1S$**

**29,500.-**

**1 pc 1 กล่อง**

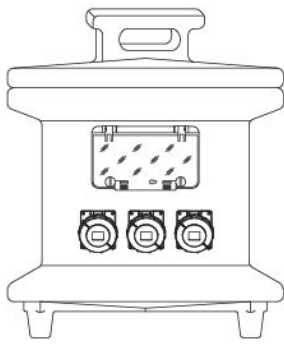
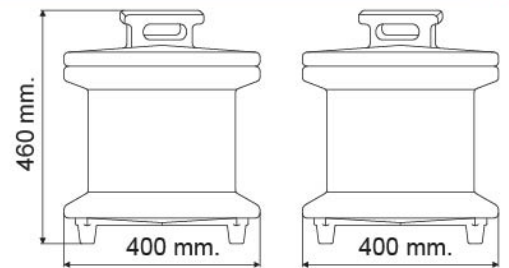

2P+E
 230V 50A,60Hz
 16A IP67  
 6H

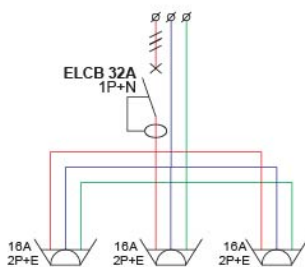

**MODEL : B0101 Side A**  
 ELCB 32A/1P+N 1 Pcs  
 P2-3132-6h 3 Pcs  
 Panel Mounted Straight Socket  
 16A/2P+E 220V  
 IP67

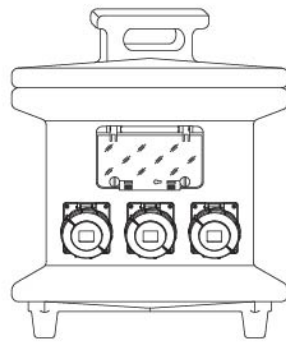

2P+E
 220V 50A,60Hz
 32A IP67  
 6H

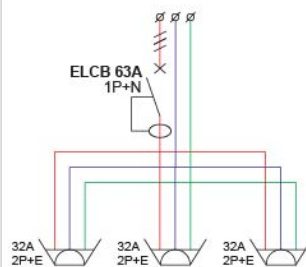

**MODEL : B0101 Side B**  
 ELCB 63A/1P+N 1 Pcs  
 P2-3232-6h 3 Pcs  
 Panel Mounted Straight Socket  
 32A/2P+E 220V  
 IP67

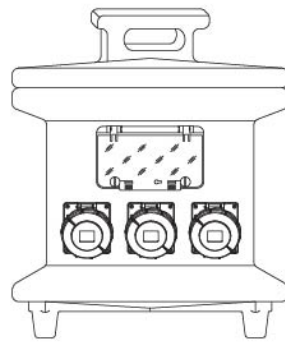

2P+E
 220V 50A,60Hz
 32A IP67  
 6H

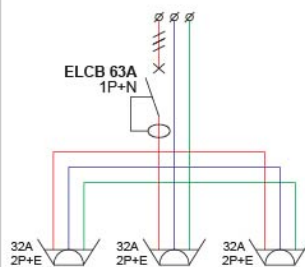

**MODEL : B0101 Side C**  
 ELCB 63A/1P+N 1 Pcs  
 P2-3232-6h 3 Pcs  
 Panel Mounted Straight Socket  
 32A/2P+E 220V  
 IP67

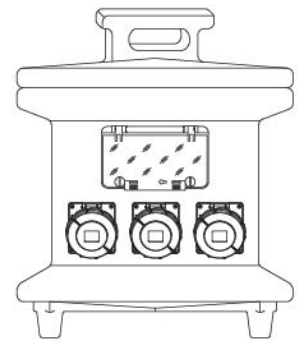

3P+N+E
 400V 50A,60Hz
 32A IP67  
 6H

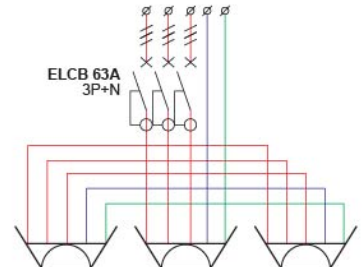

**MODEL : B0101 Side D**  
 ELCB 63A/3P+N 1 Pcs  
 P2-3252-6h 3 Pcs  
 Panel Mounted Straight Socket  
 32A/3P+N+E 380V  
 IP67



บริษัท สยาม โกลบอล กรุ๊ป จำกัด

SIAM GLOBAL GROUP CO.,LTD.

[www.sgb.co.th](http://www.sgb.co.th)